

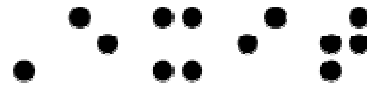

# Emergency Evacuation Planning Guide For People with Disabilities



Copyright © 2007 National Fire Protection Association

All or portions of this work may be reproduced, displayed or distributed for personal or non-commercial purposes. Commercial reproduction, display or distribution may only be with permission of the National Fire Protection Association.

June 2007



## TABLE OF CONTENTS

Summary.....	3
Preface.....	6
Chapter 1 <b>General Information</b> .....	8
Chapter 2 <b>Building an Evacuation Plan for People with Mobility Impairments</b> .....	15
Chapter 3 <b>Building an Evacuation Plan for People with Visual Impairments</b> .....	22
Chapter 4 <b>Building an Evacuation Plan for People with Hearing Impairments</b> .....	28
Chapter 5 <b>Building an Evacuation Plan for People with Speech Impairments</b> .....	31
Chapter 6 <b>Building an Evacuation Plan for People with Cognitive Impairments</b> .....	33
Personal Emergency Evacuation Planning Checklist.....	36
Annex A <b>The ADA: A Beginning</b> .....	41
Annex B <b>Government Resources</b> .....	44
Annex C <b>Excerpts from U.S. Access Board’s ADA-ABA-AG (July 2004)</b> .....	50
Annex D <b>Selected Examples of the Scope of the ADA</b> .....	59



## SUMMARY

The NFPA *Emergency Evacuation Planning Guide for People with Disabilities* has been developed with input from the disability community to provide general information on this important topic. In addition to providing information on the five general categories of disabilities (mobility impairments, visual impairments, hearing impairments, speech impairments, and cognitive impairments), the *Guide* outlines the four elements of evacuation information that occupants need: notification, way finding, use of the way, and assistance. Also included is a Personal Emergency Evacuation Planning Checklist that building services managers and people with disabilities can use to design a personalized evacuation plan. The annexes give government resources and text based on the relevant code requirements and ADA criteria.

## OVERVIEW

The NFPA *Emergency Evacuation Planning Guide for People with Disabilities* was developed in response to the emphasis that has been placed on the need to properly address the emergency procedure needs of the disability community. This *Guide* addresses the needs, criteria, and minimum information necessary to integrate the proper planning components for the disabled community into a comprehensive evacuation planning strategy. This *Guide* is available to everyone in a free, downloadable format from the NFPA website, [www.nfpa.org](http://www.nfpa.org).

Additionally a link is available for users of the *Guide* to provide comments or changes to the *Guide* that should be considered for future versions. It is anticipated that the content will be updated annually or more frequently, as necessary, to recognize new ideas, concepts, and technologies.

While building codes in the United States have continuously improved, containing requirements that reduce damage and injury to people and property by addressing fire sprinklers, fire-resistive construction materials, and structural stability, equally important issues such as energy efficiency, protection of heritage buildings, and accessibility are relatively recent subjects that we've begun to address in codes.

Many newer buildings are constructed as “accessible” or “barrier free” to allow people with disabilities ready access. Equally important is how building occupants with a variety of disabilities are notified of a building emergency, how they respond to a potentially catastrophic event, whether or not appropriate features or systems are provided to assist them during an emergency, and what planning and operational strategies are in place to help ensure “equal egress” during an emergency.

Visual as well as audible fire alarm system components, audible/directional-sounding alarm devices, areas of refuge, stair-descent devices, and other code-based technologies clearly move us in the right direction to address those issues. This *Guide* is a tool to provide assistance to people with disabilities, employers,



building owners and managers, and others as they develop emergency evacuation plans that integrate the needs of people with disabilities and that can be used in all buildings, old and new. The *Guide* includes critical information on the operational, planning, and response elements necessary to develop a well-thought-out plan for evacuating a building or taking other appropriate action in the event of an emergency. All people, regardless of circumstances, have some obligation to be prepared to take action during an emergency and to assume responsibility for their own safety.

**About NFPA:** NFPA has been a worldwide leader in providing fire, electrical, building, and life safety to the public since 1896. The mission of this international nonprofit organization is to reduce the worldwide burden of fire and other hazards on the quality of life by providing and advocating consensus codes and standards, research, training, and education.

**Contact:** This *Guide* was prepared by NFPA staff. Contact Allan B. Fraser, Senior Building Code Specialist, with comments and suggestions at [afraser@nfpa.org](mailto:afraser@nfpa.org) or 617-984 7411.



## PREFACE

The first version of the Americans with Disabilities Act (ADA) that went before Congress was crafted by President Ronald Reagan's appointees to the National Council on Disability. Even at that time (late 1980s), the disability movement included conservatives as well as liberals and was unified in the view that what was needed was not a new and better brand of social welfare system but a fundamental examination and redefinition of the democratic tradition of equal opportunity and equal rights.

In just two years, Congress passed the ambitious legislation, and in 1990 President George Bush held the largest signing ceremony in history on the south lawn of the White House, a historic moment for all people with disabilities. To some degree, passage of the ADA was brought about by members of Congress realizing their obligation to ensure civil rights for all Americans. The benefits of the ADA extend to a broad range of people by cutting across all sectors of society; virtually everyone has already experienced positive benefits from the law or knows someone who has. According to some studies, as many as two-thirds of people with disabilities are unemployed. This is largely due to attitudinal and physical barriers that prevent their access to available jobs. With a labor-deficit economy, the national sentiment opposed to long-term welfare reliance, and the desire of people with disabilities to be economically independent and self-supporting, employment of people with disabilities is essential.

The ADA is historic not only nationally but globally as well. No other mandate in the world has its scope. Other nations may provide greater levels of support services and assistive technology, but the United States ensures equal rights within a constitutional tradition. The ADA has unique appeal for all Americans because, unlike other civil rights categories such as race and gender, any one of us could become a member of the protected class at any moment in our lives.

The National Fire Protection Association (NFPA) is a codes and standards development organization, not an enforcement agency. The purpose of this *Guide* is simply to help people with disabilities, employers, building owners and managers, and others look at some of the issues that are relevant to a person's ability to evacuate a building in the event of an emergency. This document is not intended to be a method or tool for compliance, nor is it a substitute for compliance with any federal, state, or local laws, rules, or regulations. All proposed alternative methods or physical changes should be checked against appropriate codes and enforcing authorities should be consulted to ensure that all proper steps are taken and required approvals are obtained.

It is important to note that employers and building/facility owners and operators have certain legal responsibilities to prevent discrimination against people with disabilities in areas within their control, including but not limited to employment, transportation, housing, training, and access to goods, programs, and activities. Equal facilitation is required for any service provided. Employers and building/facility owners and operators are strongly encouraged to seek guidance



from qualified professionals with respect to compliance with the applicable laws for individual programs and facilities. See Annex C for areas covered by the ADA.

NFPA may not be able to resolve all the accessibility issues that we face in our lives, but it certainly can provide for accessibility in the built environment where it is regulated through codes and standards.

This *Guide* has been written to help define, coordinate, and document the information building owners and managers, employers, and building occupants need to formulate and maintain evacuation plans for people with disabilities, whether those disabilities are temporary or permanent, moderate or severe.

## USING THIS GUIDE TO DESIGN AN EVACUATION PLAN

This *Guide* is arranged by disability category. Use the Personal Emergency Evacuation Planning Checklist to check off each step and add the appropriate information specific to the person for whom the plan is being built.

Once the plan is complete, it should be practiced to be sure that it can be implemented appropriately and to identify any gaps or problems that require refinement so that it works as expected. Then copies should be filed in appropriate locations for easy access and given to the assistants, supervisors, co-workers, and friends of the person with the disability; building managers and staff; and municipal departments that may be first responders.

The plan should also be reviewed and practiced regularly by everyone involved. People who have a service animal should practice the evacuation drills with their service animals.

The importance of practicing the plan cannot be overemphasized. Practice solidifies everyone's grasp of the plan, assists others in recognizing the person who may need assistance in an emergency, and brings to light any weaknesses in the plan.

While standard drills are essential, everyone should also be prepared for the unexpected. Building management should conduct unannounced as well as announced drills and vary the drills to pose a variety of challenges along designated evacuation routes, such as closed-off corridors/stairs, blocked doors, or unconscious people.

Practice and planning do make a difference. During the 1993 bombing of the World Trade Center, a man with a mobility impairment was working on the 69th floor. With no plan or devices in place, it took over six hours to evacuate him. In the 2001 attack on the World Trade Center, the same man had prepared himself to leave the building using assistance from others and an evacuation chair he had acquired and had under his desk. It only took 1 hour and 30 minutes to get him out of the building this second time.



Emergency evacuation plans should be viewed as living documents. With building management staff, everyone should regularly practice, review, revise, and update their plans to reflect changes in technology, personnel, and procedures



## Chapter 1

### GENERAL INFORMATION

Most people will, at some time during their lives, have a disability, either temporary or permanent, that will limit their ability to move around inside or outside a building and to easily use the built environment. In fact, more than one in five Americans ages 15 and over have some type of disability; problems with walking and lifting are the most common.

The original statistics in the following list are from “Statistical Report: The Status of People with Disabilities,” published in 1994 by the President’s Committee on Employment of People with Disabilities, now the Office of Disability Employment Policy (ODEP). The updated numbers (in parentheses) for 2000 are from the U.S. Census Bureau, and those for 2003 are from the National Center for Health Statistics.

- ◆ 48.9 million Americans have one or more disabilities (49.7 million in 2000).
- ◆ 32 million Americans are age 65 or over (33.3 million in 2000).
- ◆ 3.3 million Americans are age 85 and older, a number that is projected to grow by 100 percent, to over 6 million, by 2010.
- ◆ 70 percent of all Americans will, at some time in their lives, have a temporary or permanent disability that makes stair climbing impossible.
- ◆ 8,000 people survive traumatic spinal cord injuries each year, returning to homes that are inaccessible.
- ◆ 17 million Americans have serious hearing disabilities (32.5 million in 2003).
- ◆ 8.1 million Americans have visual disabilities (18.6 million in 2003).
- ◆ 27 million Americans have heart disease and subsequent reduced or limited mobility (31.3 million in 2003).

Disabilities manifest themselves in varying degrees, and the functional implications of the variations are important for emergency evacuation. One person may have multiple disabilities, while another may have a disability whose symptoms fluctuate. Everyone needs to have a plan to be able to evacuate a building, regardless of his or her physical condition.

While planning for every situation that may occur in every type of an emergency is impossible, being as prepared as possible is important. One way to accomplish this is to consider the input of various people and entities, from executive management, human resources, and employees with disabilities to first responders and other businesses, occupants, and others nearby. Involving such people early on will help everyone understand the evacuation plans and the challenges that businesses, building owners and managers, and people with disabilities face. The





issues raised in this *Guide* will help organizations prepare to address the needs of people with disabilities, as well as others, during an emergency.

This *Guide* was developed using the five general categories of disabilities recognized in the *Fair Housing Act Design Manual*. It addresses the four elements of “standard” building evacuation information that apply to everyone but that may require modification or augmentation to be of use to people with disabilities. Most accessibility standards and design criteria are based on the needs of people defined by one of the following five general categories:

### The Five General Categories of Disabilities

- ◆ Mobility impairments
- ◆ Visual impairments
- ◆ Hearing impairments
- ◆ Speech impairments
- ◆ Cognitive impairments

### The Four Elements of Evacuation Information That People Need

- ◆ Notification (What is the emergency?)
- ◆ Way finding (Where is the way out?)
- ◆ Use of the way (Can I get out by myself, or do I need help?)
  - ❖ Self
  - ❖ Self with device
  - ❖ Self with assistance
- ◆ Assistance (What kind of assistance might I need?)
  - ❖ Who
  - ❖ What
  - ❖ Where
  - ❖ When
  - ❖ How

## GENERAL CATEGORIES OF DISABILITIES

### Mobility Impairments

#### *Wheelchair Users*

People with mobility disabilities may use one or more devices, such as canes, crutches, a power-driven or manually operated wheelchair, or a three-wheeled cart or scooter, to maneuver through the environment. People who use such devices



have some of the most obvious access/egress problems. Typical problems include maneuvering through narrow spaces, going up or down steep paths, moving over rough or uneven surfaces, using toilet and bathing facilities, reaching and seeing items placed at conventional heights, and negotiating steps or changes in level at the entrance/exit point of a building.

### *Ambulatory Mobility Disabilities*

This subcategory includes people who can walk but with difficulty or who have a disability that affects gait. It also includes people who do not have full use of their arms or hands or who lack coordination. People who use crutches, canes, walkers, braces, artificial limbs, or orthopedic shoes are included in this category. Activities that may be difficult for people with mobility disabilities include walking, climbing steps or slopes, standing for extended periods of time, reaching, and fine finger manipulation.

Generally speaking, if a person cannot physically negotiate, use, or operate some part or element of a standard building egress system, like stairs or the door locks or latches, then that person has a mobility impairment that affects his or her ability to evacuate in an emergency unless alternatives are provided.

### *Respiratory Impairments*

People with a respiratory impairments can generally use the components of the egress system but may have difficulty safely evacuating due to dizziness, nausea, breathing difficulties, tightening of the throat, or difficulty concentrating. Such people may require rest breaks while evacuating.

### **Visual Impairments**

This category includes people with partial or total vision loss. Some people with a visual disability can distinguish light and dark, sharply contrasting colors, or large print but cannot read small print, negotiate dimly lit spaces, or tolerate high glare. Many people who are blind depend on their sense of touch and hearing to perceive their environment. For assistance while in transit, walking, or riding, many people with visual impairments use a white cane or have a service animal. There is a risk that a person with a visual impairment would miss a visual cue, such as a new obstruction that occurred during the emergency event, that could affect egress.

Generally speaking, if a person cannot use or operate some part or element of a standard building egress system or access displayed information, like signage, because that element or information requires vision in order to be used or understood, then that person has a visual impairment that could affect his or her ability to evacuate in an emergency unless alternatives are provided.

### **Hearing Impairments**

People with partial hearing often use a combination of speech reading and hearing aids, which amplify and clarify available sounds. Echo, reverberation, and extraneous background noise can distort hearing aid transmission. People who are



deaf or hard of hearing and who rely on lip reading for information must be able to clearly see the face of the person who is speaking. Those who use sign language to communicate may be adversely affected by poor lighting. People who are hard of hearing or deaf may have difficulty understanding oral communication and receiving notification by equipment that is exclusively auditory, such as telephones, fire alarms, and public address systems. There is a risk that a person with a hearing loss or deafness would miss an auditory cue to the location of a dangerous situation, affecting his or her ability to find safe egress.

Generally speaking, if a person cannot receive some or all of the information emitted by a standard building egress system, like a fire alarm horn or voice instructions, then that person has a hearing impairment that could affect his or her ability to evacuate in an emergency unless alternatives are provided.

### **Speech Impairments**

Speech impairments prevent a person from using or accessing information or building features that require the ability to speak. Speech impairments can be caused by a wide range of conditions, but all result in some level of loss of the ability to speak or to verbally communicate clearly.

The only “standard” building egress systems that may require a person to have the ability to speak in order to evacuate a building are the emergency phone systems in areas of refuge, elevators, or similar locations. These systems need to be assessed in the planning process.

### **Cognitive Impairments**

Cognitive impairments prevent a person from using or accessing building features due to an inability to process or understand the information necessary to use those features.

Cognitive impairments can be caused by a wide range of conditions, including but not limited to developmental disabilities, multiple sclerosis, depression, alcoholism, Alzheimer’s disease, Parkinson disease, traumatic brain injury, chronic fatigue syndrome, stroke, and some psychiatric conditions, but all result in some decreased or impaired level in the ability to process or understand the information received by the senses.

All standard building egress systems require a person to be able to process and understand information in order to safely evacuate a building.

### **Other Impairments and Multiple Impairments**

In addition to people with permanent or long-term disabilities, there are others who have temporary conditions that affect their usual abilities. Broken bones, illness, trauma, or surgery can affect a person’s use of the built environment for a short time. Diseases of the heart or lungs, neurological diseases with a resulting lack of coordination, arthritis, and rheumatism can reduce a person’s physical stamina or cause pain. Other disabilities include multiple chemical sensitivities and seizure disorders. Reduction in overall ability is also experienced by many



people as they age. People of extreme size or weight often need accommodation as well.

It is not uncommon for people to have multiple disabilities. For example, someone could have a combination of visual, speech, and hearing disabilities. Evacuation planning for people with multiple disabilities is essentially the same process as for those with individual disabilities, although it will require more steps to develop and complete more options or alternatives.

## SERVICE ANIMALS

Service animals assist people with disabilities in their day-to-day activities. While most people are familiar with guide dogs trained to assist people with visual impairments, service animals can be trained for a variety of tasks, including alerting a person to sounds in the home and workplace, pulling a wheelchair, picking up items, or assisting with balance.



The ADA defines a service animal “as any guide dog, signal dog, or other animal individually trained to provide assistance to a person with a disability.” Service animals do not have to be licensed or certified by state or local government. Under the ADA, they are permitted in private facilities that serve the public, including shelters, hospitals, and emergency vehicles; in state and local government facilities; and in the workplace.

Only under the following rare and unusual circumstances can a service animal be excluded from a facility:

- ◆ The animal’s behavior poses a direct threat to the health or safety of others.
- ◆ The animal’s presence would result in a fundamental alteration to the nature of a business or a state or local government’s program or activity.
- ◆ The animal would pose an “undue hardship” for an employer. Such instances would include a service animal that displays vicious behavior toward visitors or co-workers or a service animal that is out of control. Even in those situations, the public facility, state or local government, or employer must give the person with a disability the opportunity to enjoy its goods, services, programs, activities, and/or equal employment opportunities without the service animal (but perhaps with some other accommodation).

A person with a service animal should relay to emergency management personnel his or her specific preferences regarding the evacuation and handling of the animal. Those preferences then need to be put in the person’s evacuation plan and shared with the appropriate building and management personnel.



People with service animals should also discuss how they can best be assisted if the service animal becomes hesitant or disoriented during the emergency situation. The procedure should be practiced so that everyone, including the service animal, is comfortable with it.

First responders should be notified of the presence of a service animal and be provided with specific information in the evacuation plan. Extra food and supplies should be kept on hand for the service animal.

## STANDARD BUILDING EVACUATION SYSTEMS

A standard building evacuation system has three components:

1. The *circulation path*
2. The *occupant notification system(s)*
3. *Directions to and through the circulation paths*

### Circulation Path

A *circulation path* is a continuous and unobstructed way of travel from any point in a building or structure to a public way.

The components of a circulation path include but are not limited to rooms, corridors, doors, stairs, smokeproof enclosures, horizontal exits, ramps, exit passageways, escalators, moving walkways, fire escape stairs, fire escape ladders, slide escapes, alternating tread devices, areas of refuge, and elevators.

A circulation path is considered a *usable circulation path* if it meets one of the following criteria:

- ◆ A person with disabilities is able to travel unassisted through the circulation path to a public way.
- ◆ A person with disabilities is able to travel unassisted through that portion of the circulation path necessary to reach an area of refuge. (See 7.2.12 of [NFPA 101<sup>®</sup>, Life Safety Code<sup>®</sup>](#), for more information.)

An *area of refuge* serves as a temporary haven from the effects of a fire or other emergency. The person with disabilities must have the ability to travel from the area of refuge to the public way, although such travel might depend on the assistance of others. If elevation differences are involved, an elevator or other evacuation device might be used, or the person might be moved by other people using a cradle carry, a swing (seat) carry, or an in-chair carry or by a stair descent device. (See 7.2.12 of [NFPA 101<sup>®</sup>, Life Safety Code<sup>®</sup>](#), for more information.)

A usable circulation path would also be one that complies with the applicable requirements of ICC/ANSI A117.1, *American National Standard for Accessible and Usable Buildings and Facilities*, for the particular disabilities involved.



## Occupant Notification System

The *occupant notification systems* include but are not limited to alarms and public address systems.

[\*NFPA 72\*](#)<sup>®</sup>, *National Fire Alarm Code*, defines a *notification appliance* as “a fire alarm system component such as a bell, horn, speaker, light, or text display that provides audible, tactile, or visible outputs, or any combination thereof.”

## Directions to and through the Usable Circulation Path

*Directions to and through the usable circulation path* include signage, oral instructions passed from person to person, and instructions, which may be live or automated, broadcast over a public address system.



Personal notification devices, which have recently come onto the market, can be activated in a number of ways, including but not limited to having a building’s alarm system relay information to the device. The information can be displayed in a number of forms and outputs. Because this technology is new to the market, such devices and systems are not discussed here; however, emergency evacuation personnel and people with disabilities may want to investigate them further.

## Chapter 2

# BUILDING AN EVACUATION PLAN FOR A PERSON WITH A MOBILITY IMPAIRMENT

### OCCUPANT NOTIFICATION SYSTEMS

*No Special Requirements.* People with mobility impairments can hear standard alarms and voice announcements and can see activated visual notification appliances (strobe lights) that warn of danger and the need to evacuate. No additional planning or special accommodations for this function are required.

### WAY FINDING

#### Is There a Usable Circulation Path?

A circulation path is considered a *usable circulation path* if it meets one of the following criteria:

- ◆ A person with disabilities is able to travel unassisted through it to a public way.
- ◆ A person with disabilities is able to travel unassisted through that portion of the circulation path necessary to reach an area of refuge.

An *area of refuge* serves as a temporary haven from the effects of a fire or other emergency. A person with a severe mobility impairment must have the ability to travel from the area of refuge to the public way, although such travel might depend on the assistance of others. If elevation differences are involved, an elevator or other evacuation device might be used, or others might move the person by using a wheelchair carry on the stairs.



#### Special Note 1

People with mobility impairments need to know if there is a usable circulation path from the building they are in. If there is not a usable circulation path, then their plans will require alternative routes and methods of evacuation to be put in place.

#### Which Circulation Paths Are Usable Circulation Paths?

Exits, other than main exterior exit doors that obviously and clearly are identifiable as exits, should be marked by approved signs that are readily visible from any direction of approach in the exit access.

Where not all circulation paths are usable by people with disabilities, the usable circulation path(s) should be clearly identified by the international symbol of accessibility:



Locations of exit signs and directional exit signs are specified by model codes. Usually the signs are placed above exit doors and near the ceiling.

Supplemental directional exit signs may be necessary to clearly delineate the route to the exit. Exit signs and directional exit signs should be located so they are readily visible and should contrast against their surroundings.



#### **Special Note 2**

People with mobility impairments should be provided with some form of written directions, a brochure, or a map showing all directional signs to all usable circulation paths. For new employees and other regular users of the facility it may be practical to physically show them the usable circulation paths as well as provide them with written information. In addition, simple floor plans of the building that show the locations of and routes to usable circulation paths should be available and given to visitors with mobility impairments when they enter the building. A large sign could be posted at each building entrance stating the availability of written directions or other materials and where to pick them up. Building security personnel, including those staffing entrance locations, should be trained in all the building evacuation systems for people with disabilities and be able to direct anyone to the nearest usable circulation path.

### **Which Paths Lead to Usable Circulation Paths?**

Any circulation paths that are not usable should include signs directing people to other, usable paths. People with mobility impairments should be provided with written directions, a brochure, or a map showing what those signs look like and where they are.



#### **Special Note 3**

Where such directional signs are not in place, people with mobility impairments should be provided with written directions, a brochure, or a map showing the locations of all usable circulation paths.



## USE OF THE WAY

### Can People with Mobility Impairments Use the Usable Circulation Path by Themselves?

#### *Is There a Direct Exit to Grade (or a Ramp)?*

A circulation path is considered a *usable circulation path* if it meets one of the following criteria:

- ◆ A person using a wheelchair is able to travel unassisted through it to a public way (if elevation differences are involved, there are usable ramps rather than stairs).
- ◆ A person using a wheelchair is able to travel unassisted through that portion of the usable circulation path necessary to reach an area of refuge.

An *area of refuge* serves as a temporary haven from the effects of a fire or other emergency. People with mobility impairments must be able to travel from the area of refuge to the public way, although such travel might depend on the assistance of others. If elevation differences are involved, an elevator or other evacuation device might be used, or the person might be moved by another person or persons using a cradle carry, a swing (seat) carry, or an in-chair carry. Training, practice, and an understanding of the benefits and risks of each technique for a given person are important aspects of the planning process.



#### Special Note 4

Not all people using wheelchairs or other assistive devices are capable of navigating a usable circulation path by themselves. It is important to verify that each person using any assistive device can travel unassisted through the usable circulation path to a public way. Those who cannot must have the provision of appropriate assistance detailed in their emergency evacuation plans. Additionally, the plans should provide for evacuation of the device or the availability of an appropriate alternative once the person is outside the building. Otherwise, the person with the mobility impairment will no longer have independent mobility once he or she is out of the emergency situation.

#### *Can the Person with a Mobility Impairment Use Stairs?*

Not all people with mobility impairments use wheelchairs. Some mobility impairments prevent a person from using building features that require the use of one's arms, hands, fingers, legs, or feet. People with mobility impairments may be able to go up and down stairs easily but have trouble operating door locks, latches, and other devices due to impairments of their hands or arms. The evacuation plans for these people should address alternative routes, alternative devices, or specific provisions for assistance.

## Are There Devices to Help People with Mobility Impairments Evacuate?

### *Can the Elevators Be Used?*

Although elevators can be a component of a usable circulation path, restrictions are imposed on the use of elevators during some types of building emergencies. Elevators typically return to the ground floor when a fire alarm is activated and can be operated after that only by use of a “firefighters” keyed switch. This may not be true in the event of non-fire emergencies requiring an evacuation. In the last several years, however, building experts have increasingly joined forces to carefully consider building elevators that are safer for use in the event of an emergency.



In October 2003, the National Institute of Standards and Technology (NIST) began working with the elevator industry to develop and test more reliable emergency power systems and waterproof components. Under consideration are software and sensing systems that adapt to changing smoke and heat conditions, helping to maintain safe and reliable elevator operation during fire emergencies. Such changes could allow remote operation of elevators during fires, thus freeing fire fighters to assist in other ways during an emergency.

The topic was further examined in March 2004 during the Workshop on the Use of Elevators in Fires and Other Emergencies co-sponsored by the American Society of Mechanical Engineers (ASME International), NIST, the International Code Council (ICC), the National Fire Protection Association (NFPA), the U.S. Access Board, and the International Association of Fire Fighters (IAFF). The workshop provided a forum for brainstorming and formulating recommendations in an effort to improve codes and standards.

The majority of recommendations led to the formation of two new ASME task groups: the Use of Elevators by Firefighters task group and the Use of Elevators for Occupant Egress task group. The project is a collaborative effort of ASME, NIST, ICC, NFPA, IAFF, the U.S. Department of Homeland Security (DHS), and the U.S. Access Board. For more information, visit [www.asme.org](http://www.asme.org).

Here again, good planning and practice are key elements of a successful evacuation.

### *Are Lifts Available?*

Lifts generally have a short vertical travel distance, usually less than 10 feet, and therefore can be an important part of an evacuation. Lifts should be checked to make sure they have emergency power, can operate if the power goes out, and if so, for how long or how many uses. It is important to know whether the building’s emergency power comes on automatically or a switch or control needs to be activated.



### *What Other Devices Are Available?*

Some evacuation devices and methods, including stair-descent devices and the wheelchair carry, require the assistance of others.



## **IS ASSISTANCE REQUIRED?**

### **Who Will Provide the Assistance?**

#### *Anyone in the Office or Building*

People with mobility impairments who are able to go up and down stairs easily but have trouble operating door locks, latches, and other devices due to impairments of their hands or arms can be assisted by anyone. A viable plan to address this situation may be for the person with the disability to be aware that he or she will need to ask someone for assistance with a particular door or a particular device. It is important to remember that not everyone in a building is familiar with all the various circulations paths everywhere in the building and that they may have to use an unfamiliar one in the event of an emergency.

#### *Specific Person(s) in the Office or Building*

- ◆ Friend or co-worker
  - ❖ Relative
  - ❖ Supervisor
  - ❖ Building staff
  - ❖ Floor safety warden
- ◆ First responders
  - ❖ Floor safety warden
  - ❖ Fire fighter
  - ❖ Police officer
  - ❖ Emergency medical services: emergency medical technicians (EMTs), ambulance personnel

## How Many People Are Necessary to Provide Assistance?

### *One Person*

When only one person is necessary to assist a person with a mobility impairment, a practical plan should identify at least two, ideally more, people who are willing and able to provide assistance. Common sense tells us that a specific person may not be available at any given time due to illness, vacation, an off-site meeting, and so on. The identification of multiple people who are likely to have different working and traveling schedules provides a more reliable plan.

### *Multiple People*

When more than one person is necessary to assist a person with a mobility impairment, a practical plan should identify at least twice the number of people required who are willing and able to provide assistance. Common sense tells us that one or more specific people may not be available at any given time due to illness, vacation, off-site meetings, and so on. The identification of a pool of people who are likely to have different working and traveling schedules provides a more reliable plan.



## What Assistance Will the Person(s) Provide?

### *Guidance*

- ◆ Explaining how and where the person needs to go to get to the usable circulation path
- ◆ Escorting the person to and/or through the usable circulation path

### *Minor Physical Effort*

- ◆ Offering an arm to assist the person to/through usable circulation path
- ◆ Opening the door(s) in the usable circulation path

### *Major Physical Effort*

- ◆ Operating a stair-descent device
- ◆ Participating in carrying a wheelchair down the stairs
- ◆ Carrying a person down the stairs

### *Waiting for First Responders*

Waiting with the person with the impairment for first responders would likely be a last choice when there is an imminent threat to people in the building. While first responders do their best to get to a site and the particular location of those needing their assistance, there is no way of predicting how long any given area will remain a safe haven under emergency conditions.



This topic should be discussed in the planning stage. Agreement should be reached regarding how long the person giving assistance is expected to wait for the first responders to arrive. Such discussion is important because waiting too long can endanger more lives. If someone is willing to delay his or her own evacuation to assist a person with an impairment in an emergency, planning how long that wait might be is wise and reasonable.

## **Where Will the Person(s) Start Providing Assistance?**

### *From the Location of the Person Requiring Assistance*

Does the person providing assistance need to go where the person with the mobility impairment is located at the time the alarm sounds? If so, how will he or she know where the person needing assistance is?

- ◆ Face to face
- ◆ Phone
- ◆ PDA
- ◆ E-mail
- ◆ Visual
- ◆ Other

### *From a Specific, Predetermined Location*

- ◆ Entry to stairs
- ◆ Other

## **When Will the Person(s) Provide Assistance?**

- ◆ Always
- ◆ Only when asked
- ◆ Other

## **How Will the Person(s) Providing Assistance Be Contacted?**

- ◆ Face to face
- ◆ Phone
- ◆ PDA
- ◆ E-mail
- ◆ Visual
- ◆ Other



## Chapter 3

# BUILDING AN EVACUATION PLAN FOR A PERSON WITH A VISUAL IMPAIRMENT

### OCCUPANT NOTIFICATION SYSTEMS

*No Special Requirements.* People with visual impairments can hear standard building fire alarms and voice announcements over public address systems that warn of a danger or the need to evacuate or that provide instructions. Therefore, no additional planning or special accommodations for this function are required.

### WAY FINDING

#### Is There a Usable Circulation Path?

A circulation path is considered a *usable circulation path* if it meets one of the following criteria:

- ◆ A person with disabilities is able to travel unassisted through it to a public way.
- ◆ A person with disabilities is able to travel unassisted through that portion of the circulation path necessary to reach an area of refuge.

An *area of refuge* is a space that serves as a temporary haven from the effects of a fire or other emergency. A person with a visual impairment must be able to travel from the area of refuge to the public way, although such travel might depend on the assistance of others.



#### Special Note 5

A person with a visual impairment needs to know if there is a usable circulation path from the building. If there is not a usable circulation path, then the personal emergency evacuation plan for that person will require that alternative routes and methods of evacuation be put in place.

#### For People with Disabilities, Which Circulation Paths Are Usable, Available, and Closest?

Exits should be marked by tactile signs that are properly located so they can be readily found by a person with a visual impairment from any direction of approach to the exit access.

Where not all circulation paths are usable by people with disabilities, the usable circulation paths should be identified by the tactile international symbol of accessibility:



The location of exit signage and directional signage for those with visual impairments is clearly and strictly specified by codes. The requirements include but are not limited to the type, size, spacing, and color of letters for visual characters and the type, size, location, character height, stroke width, and line spacing of tactile letters or Braille characters. The specific code requirements are included in Annex C.



#### Special Note 6

It may be practical to physically take new employees with visual impairments to and through the usable circulation paths and to all locations of directional signage to usable circulation paths. In addition, simple floor plans of the building indicating the location of and routes to usable circulation path should be available in alternative formats such as single-line, high-contrast plans. These plans should be given to visitors with visual impairments when they enter the building so they can find the exits in an emergency. Tactile and Braille signs should be posted at the building entrances stating the availability of the floor plans and where to pick them up. Building security personnel, including those staffing the entrances, should be trained in all accessible building evacuation systems and be able to direct anyone to the nearest usable circulation path.



#### Special Note 7

The personal evacuation plan for a person with a visual impairment needs to be prepared and kept in the alternative format preferred by that person, including but not limited to Braille, large type, or tactile characters.

### Which Paths Are Usable Circulation Paths?

Tactile directional signs that indicate the location of the nearest usable circulation path should be provided at all circulation paths that are not usable by people with disabilities. It may be practical to physically show new employees with visual impairments where all usable circulation paths are.



## Special Note 8

Where tactile directional signs are not in place, it may be practical to physically show new employees with visual impairments where all usable circulation paths are located. Building management should consider installing appropriate visual, tactile, and/or Braille signage in appropriate locations conforming to the code requirements in Annex C. Installing such signage is generally not expensive. Building owners and managers may be unaware that there is something they can do to facilitate the safe evacuation of people with visual impairments.



A new technology in fire safety generically called “directional sound” is coming on the market. Traditional fire alarm systems are designed to *notify* people but not necessarily to *guide* them. Directional sound is an audible signal that leads people to safety in a way that conventional alarms cannot, by communicating the location of exits using broadband noise. The varying tones and intensities coming from directional sound devices offer easy-to-discern cues for finding the way out. As soon as people hear the devices, they intuitively follow them to get out quickly. While not yet required by any codes, directional sound is a technology that warrants investigation by building services management.

## USE OF THE WAY

### Can People with Visual Impairments Use the Circulation Path by Themselves?

A circulation path is considered a *usable circulation path* if it meets one of the following criteria:

- ◆ A person with a visual impairment is able to travel unassisted through it to a public way.
- ◆ A person with a visual impairment is able to travel unassisted through that portion of the usable circulation path necessary to reach an area of refuge.

An *area of refuge* serves as a temporary haven from the effects of a fire or other emergency. A person with a visual impairment must be able to travel from the area of refuge to the public way, although such travel might depend on the assistance of others. If elevation differences are involved, an elevator might be used, or the person might be led down the stairs.

### Will a Person with a Visual Impairment Require Assistance to Use the Circulation Path?

Not all people with visual impairments are capable of navigating a usable circulation path. It is important to verify that a person with a visual impairment





can travel unassisted through the exit access, the exit, and the exit discharge to a public way. If he or she cannot, then that person's personal emergency evacuation plan will include a method for providing appropriate assistance.

Generally only one person is necessary to assist a person with a visual impairment. A practical plan is to identify at least two, ideally more, people who are willing and able to provide assistance. Common sense tells us that a specific person may not be available at any given time due to illness, vacation, off-site meetings, and so on. The identification of multiple people who are likely to have different working and traveling schedules provides a much more reliable plan.



## IS ASSISTANCE REQUIRED?

### Who Will Provide the Assistance?

#### *Anyone in the Office or the Building*

People with visual impairments who are able to go up and down stairs easily but simply have trouble finding the way or operating door locks, latches, and other devices can be assisted by anyone. A viable plan may simply be for the person with a visual impairment to be aware that he or she will need to ask someone for assistance.

#### *Specific Person(s) in the Office or the Building*

- ◆ Friend or co-worker
  - ❖ Relative
  - ❖ Supervisor
  - ❖ Building staff
  - ❖ Floor safety warden
- ◆ First responders
  - ❖ Floor safety warden
  - ❖ Fire fighter
  - ❖ Police officer
  - ❖ Emergency medical services: emergency medical technicians (EMTs), ambulance personnel

### What Assistance Will the Person(s) Provide?

#### *Guidance*

- ◆ Explaining how to get to the usable circulation path



- ◆ Escorting the person with the visual impairment to and/or through the circulation path

#### *Minor Physical Effort*

- ◆ Offering the person an arm or allowing the person to place a hand on your shoulder and assisting the person to/through the circulation path
- ◆ Opening doors in the circulation path



#### *Waiting for First Responders*

Generally speaking, a person with a visual impairment will not need to wait for first responders. Doing so would likely be a last choice when there is an imminent threat to people in the building. While first responders do their best to get to a site and the particular location of those needing their assistance, there is no way to predict how long any given area will remain a safe haven under emergency conditions.

### **Where Will the Person(s) Start Providing Assistance?**

#### *From the Location of the Person Requiring Assistance*

Does the person providing assistance need to go where the person with the visual impairment is located at the time the alarm sounds? If so, how will he or she know where the person needing assistance is?

- ◆ Phone
- ◆ PDA
- ◆ E-mail
- ◆ Visual
- ◆ Other

#### *From a Specific, Predetermined Location*

- ◆ Entry to stairs
- ◆ Other

### **When Will the Person(s) Provide Assistance?**

- ◆ Always
- ◆ Only when asked
- ◆ Other

### **How Will the Person(s) Providing Assistance Be Contacted?**

- ◆ Face to face
- ◆ Phone



- ◆ PDA
- ◆ E-mail
- ◆ Visual
- ◆ Other



## Chapter 4

# BUILDING AN EVACUATION PLAN FOR A PERSON WITH A HEARING IMPAIRMENT

## OCCUPANT NOTIFICATION SYSTEMS

### Visual Devices for the Fire Alarm System

People with hearing impairments cannot hear alarms and voice announcements that warn of danger and the need to evacuate. Many codes require new buildings to have flashing strobe lights (visual devices) as part of the standard building alarm system, but because the requirements are not retroactive many buildings don't have them. In addition, strobes are required only on fire alarm systems and simply warn that there may be a fire. Additional information that is provided over voice systems for a specific type of emergency such as threatening weather event, or that directs people to use a specific exit, are unavailable to people with hearing impairments.



It is extremely important for people with hearing impairments to know what, if any, visual notification systems are in place. They also need to be aware of which emergencies will activate the visual notification system and which emergencies will not. Alternative methods of notification need to be put into the emergency evacuation plans for people with hearing impairments so they can get all the information they need to evacuate in a timely manner.

### Devices or Methods for Notification of Other Emergencies

The following is a partial list of emergencies that should be considered in the development of alternative warning systems:

- ◆ Natural events
  - ❖ Storms (hurricanes, tornadoes, floods, snow, lightning, hail, etc.)
  - ❖ Earthquakes (Although a system would provide only a few seconds' notice, it may lessen anxiety and prevent panic.)
- ◆ Human-caused events (robbery, hostile acts, random violence, etc.)



## Special Note 9

Scrolling reader boards are becoming more common and are being applied in creative ways. In emergency



situations, they can flash to attract attention and provide information about the type of emergency or situation. Some major entertainment venues use this technology to provide those with hearing impairments with “closed captioning” at every seat, for very little cost. A reversed scrolling reader board is mounted in the back of the room. Guests with hearing impairments are provided with small teleprompter-type screens mounted on small stands. The guests place the stands directly in front of themselves and adjust the screens so they can see the reader board reflected off the screens. The screens are transparent, so they don’t block the view of guests behind the screen users.

If a person with a hearing impairment is likely to be in one location for a significant period of time, such as at a desk in an office, installation of a reader board in the work area might be considered to provide appropriate warning in an emergency.

Personal notification devices are also coming on the market. Such devices can be activated in a number of ways, including having a building’s alarm system relay information to the device. Information can be displayed in a variety of forms and outputs.

E-mail and TTY phone communications are other alternative methods of notification for people with hearing impairments.

Another option is the use of televisions in public and working areas with the closed caption feature turned on. The U.S. Department of Agriculture offices in Washington D.C. use this technology.

## WAY FINDING

### Is Prior Knowledge of the Circulation Path Location(s) Necessary?

No Special Requirements. Once properly notified by appropriate visual notification devices of an alarm or special instructions, people with hearing impairments can use any standard means of egress from the building.

### Is Identification of Which Means of Egress Are Available/Closest Necessary?

No Special Requirements. Once notified, people with hearing impairments can use any standard means of egress from the building.

Simple floor plans of the building indicating the location of and routes to usable circulation paths should be available in alternative formats such as single-line, high-contrast plans. These plans should be given to visitors when they enter the



building so they can find the exits in an emergency. Signs in alternative formats should be posted at the building entrances stating the availability of the floor plans and where to pick them up. Building security personnel, including those staffing the entrances, should be trained in all accessible building evacuation systems and be able to direct anyone to the nearest usable circulation path.

### **Is Identification of the Path(s) to the Means of Egress Necessary?**

*No Special Requirements.* Once notified, people with hearing impairments can read and follow standard exit and directional signs.

### **USE OF THE WAY**

*No Special Requirements.* Once notified, people with hearing impairments can read and follow standard exit and directional signs and use any standard means of egress from the building.

Elevators are required to have both a telephone and an emergency signaling device. People with hearing or speech impairments should be aware of whether the telephone is limited to voice communications and where the emergency signaling device rings — whether it connects or rings inside the building or to an outside line — and who would be responding to it.

### **IS ASSISTANCE REQUIRED?**

*No Special Requirements.* Once notified, many people with hearing impairments can read and follow standard exit and directional signs and use any standard means of egress from the building. However, some may need assistance in areas of low or no light where their balance could be affected without visual references.

## Chapter 5

# BUILDING AN EVACUATION PLAN FOR A PERSON WITH A SPEECH IMPAIRMENT

### OCCUPANT NOTIFICATION SYSTEMS

No Special Requirements. People with speech impairments can hear standard alarms and voice announcements and can see visual indicators that warn of danger and the need to evacuate. Therefore, no additional planning or special accommodations for this function are required.

### WAY FINDING

#### Is Prior Knowledge of the Location of the Means of Egress Necessary?

No Special Requirements. Once notified, people with speech impairments can use any standard means of egress from the building.

#### Is Identification of Which Means of Egress Are Available/Closest Necessary?

No Special Requirements. Once notified, people with speech impairments can use any standard means of egress from the building.

Simple floor plans of the building indicating the location of and routes to usable circulation paths should be available in alternative formats such as single-line, high-contrast plans. These plans should be given to visitors when they enter the building so they can find the exits in an emergency. Signs in alternative formats should be posted at the building entrances stating the availability of the floor plans and where to pick them up. Building security personnel, including those staffing the entrances, should be trained in all accessible building evacuation systems and be able to direct anyone to the nearest usable circulation path.

#### Is Identification of the Path(s) to the Means of Egress Necessary?

No Special Requirements. Once notified, people with speech impairments can read and follow standard exit and directional signs.

### USE OF THE WAY

The only standard building egress system that may require the ability to speak in order to evacuate a building is an emergency phone in an elevator. Elevators are required to have both a telephone and an emergency signaling device. People with speech impairments should be aware of whether the telephone is limited to voice communications and where the emergency signaling device rings — whether it connects or rings inside the building or to an outside line — and who would be responding to it.



## IS ASSISTANCE REQUIRED?

*No Special Requirements.* Once notified, people with speech impairments can read and follow standard exit and directional signs and use any standard means of egress from the building. However, some may need assistance with voice communication devices in an elevator.





## Chapter 6

### BUILDING AN EVACUATION PLAN FOR A PERSON WITH A COGNITIVE IMPAIRMENT

Cognitive impairments prevent a person from using or accessing building features due to an inability to process or understand the information necessary to use the features. Cognitive impairments are caused by a wide range of conditions, but all result in some decreased level of ability to process or understand information or situations.

All standard building egress systems require the ability to process and understand information in order to safely evacuate.

Possible accommodations for people with cognitive impairments might include the following:

- ◆ Providing a picture book of drill procedures
- ◆ Color coding fire doors and exit ways
- ◆ Implementing a buddy system
- ◆ Using a job coach for training

### OCCUPANT NOTIFICATION SYSTEMS

*No Special Requirements.* People with cognitive impairments can hear standard alarms and voice announcements and see visual indicators that warn of danger and the need to evacuate. However, the ability of a person with a cognitive impairment to recognize and understand a fire alarm or other emergency notification systems and what they mean should be verified. If the person does not recognize and understand alarms, then plans for assistance need to be developed.

### WAY FINDING

#### Is Identification of Which Means of Egress Are Available/Closest Necessary?

*No Special Requirements.* However, the ability of a person with a cognitive impairment to find and use the exits should be verified. If the person is not able to recognize and use them without assistance, then plans for assistance need to be developed.

Simple floor plans of the building indicating the location of and routes to usable circulation paths should be available in alternative formats such as single-line, high-contrast plans. These plans should be given to visitors when they enter the building so they can find the exits in an emergency. Signs in alternative formats should be posted at the building entrances stating the availability of the floor plans and where to pick them up. Building security personnel, including those



staffing the entrances, should be trained in all accessible building evacuation systems and be able to direct anyone to the nearest usable circulation path.

### **Is Identification of the Path(s) to the Means of Egress Necessary?**

*No Special Requirements.* However, the ability of a person with a cognitive impairment to find and use the exits should be verified. If the person is not able to recognize and use the exits without assistance, then plans for assistance need to be developed.

### **USE OF THE WAY**

*No Special Requirements.* However, the ability of a person with a cognitive impairment to find and use the exits should be verified. If the person is not able to recognize and use the exits without assistance, then plans for assistance need to be developed.

### **IS ASSISTANCE REQUIRED?**

#### **Who Will Provide the Assistance?**

Generally, only one person is necessary to assist a person with a cognitive impairment. A practical plan should identify at least two, ideally more, people who are willing and able to provide assistance. Common sense tells us that a specific person may not be available at any given time due to illness, vacation, off-site meetings, and so on. The identification of multiple people who are likely to have different working and traveling schedules provides a much more reliable plan.

#### *Specific Person(s) in the Office or the Building*

- ◆ Special training or skills
- ◆ Known to the person with cognitive impairments

#### *Anyone in the Office or the Building*

#### **What Assistance Will the Person(s) Provide?**

- ◆ Ensuring that the person with the cognitive impairment is aware of the emergency and understands the need to evacuate the building
- ◆ Guidance to and/or through the means of egress

#### **Where Will the Person(s) Start Providing Assistance?**

- ◆ From the current location of the person needing assistance
- ◆ From a specific, predetermined location
  - ❖ Entry to stairs
  - ❖ Other



### **When Will the Person(s) Provide Assistance?**

- ◆ Always
- ◆ Only when asked
- ◆ Other

### **How Will the Person(s) Providing Assistance Be Contacted?**

- ◆ Face to face
- ◆ Phone
- ◆ PDA
- ◆ E-mail
- ◆ Visual
- ◆ Other



## PERSONAL EMERGENCY EVACUATION CHECKLIST

This checklist is also available as an interactive Microsoft® Word form at <http://www.nfpa.org/assets/files//PDF/Forms/Chklst.doc> To personalize the form, download it to your local hard drive, then copy and rename the file for each individual for whom an evacuation plan is needed. The file name will print in the footer of each page, so use short, meaningful file names, for example, MaryEvacPlan.doc. Brief instructions for working with Word tools for forms are available at <http://www.nfpa.org/assets/files//PDF/Forms/HowToUse.pdf>. For advanced instructions, see the Help resources included with Microsoft Word.





## PERSONAL EMERGENCY EVACUATION PLANNING CHECKLIST



Name: \_\_\_\_\_ Primary Location: \_\_\_\_\_

Building (home, office, etc.): \_\_\_\_\_ Primary Phone: \_\_\_\_\_

Address: \_\_\_\_\_ Cell Phone: \_\_\_\_\_

Floor: \_\_\_\_\_ E-mail: \_\_\_\_\_

Service Animal:  Yes  No

### OCCUPANT NOTIFICATION

#### Type of Emergency    Method or Device for Notification

Fire: \_\_\_\_\_

Earthquake: \_\_\_\_\_

Flood: \_\_\_\_\_

Storm: \_\_\_\_\_

Attack: \_\_\_\_\_

Other (specify): \_\_\_\_\_

	YES	NO	N/A	Comments
Are there emergency notification devices (alarms, etc.) appropriate for this person?	<input type="checkbox"/>	<input type="checkbox"/>	<input type="checkbox"/>	
Does this person know the location of each emergency notification device/system and understand its meaning/function?	<input type="checkbox"/>	<input type="checkbox"/>	<input type="checkbox"/>	
Does this person know how to sound the alert for emergencies (manual pull box alarms, public address systems, radio, telephones)?	<input type="checkbox"/>	<input type="checkbox"/>	<input type="checkbox"/>	
If telephones are used to report emergencies, are emergency numbers posted near telephones, on employee notice boards, or in other conspicuous locations?	<input type="checkbox"/>	<input type="checkbox"/>	<input type="checkbox"/>	
Is there a way for a person with a hearing or speech impairment to report an emergency?	<input type="checkbox"/>	<input type="checkbox"/>	<input type="checkbox"/>	
If the communication system also serves as an alarm system, do all emergency messages have priority over all non-emergency messages?	<input type="checkbox"/>	<input type="checkbox"/>	<input type="checkbox"/>	
Is there a unique signal (sound, light, header) to indicate an emergency message?	<input type="checkbox"/>	<input type="checkbox"/>	<input type="checkbox"/>	



## WAY FINDING

	YES	NO	N/A	Comments
Is there a usable way out?	<input type="checkbox"/>	<input type="checkbox"/>	<input type="checkbox"/>	
Where is it? (List all and indicate nearest.)				
Where is the established outside meeting place?				
Is the usable circulation path clearly marked to show the route to leave the building or to relocate to some other space within the building in an emergency?	<input type="checkbox"/>	<input type="checkbox"/>	<input type="checkbox"/>	
If a person exiting a doorway or turning a corner could inadvertently be directed into the path of a moving vehicle, is a safeguarding device with a warning sign in place?	<input type="checkbox"/>	<input type="checkbox"/>	<input type="checkbox"/>	
If the stairs in the circulation path lead anywhere but out of the building, are doors, partitions, or other effective means used to show the correct route out of the building?	<input type="checkbox"/>	<input type="checkbox"/>	<input type="checkbox"/>	
Do doors used to connect any room to a circulation path have proper maneuvering clearances?	<input type="checkbox"/>	<input type="checkbox"/>	<input type="checkbox"/>	
Can the doors be easily unlatched?	<input type="checkbox"/>	<input type="checkbox"/>	<input type="checkbox"/>	
Do exterior circulation paths (balcony, porch, gallery, roof) meet the preceding four requirements?	<input type="checkbox"/>	<input type="checkbox"/>	<input type="checkbox"/>	
Does the exterior circulation path have guardrails to protect open sides of walking surfaces?	<input type="checkbox"/>	<input type="checkbox"/>	<input type="checkbox"/>	
Is the exterior circulation path smooth, solid, and a substantially level travel surface?	<input type="checkbox"/>	<input type="checkbox"/>	<input type="checkbox"/>	
Does the exterior circulation path <i>not</i> branch off and head away from the public way?	<input type="checkbox"/>	<input type="checkbox"/>	<input type="checkbox"/>	
Is each exit marked with a clearly visible sign reading "EXIT" in all forms (visual, tactile, Braille)?	<input type="checkbox"/>	<input type="checkbox"/>	<input type="checkbox"/>	
Is every doorway or passage that might be mistaken for an exit marked "NOT AN EXIT" or with an indication of its actual use in all forms (visual, tactile, Braille)?	<input type="checkbox"/>	<input type="checkbox"/>	<input type="checkbox"/>	
Are signs posted and arranged along circulation paths to adequately show how to get to the nearest exit?	<input type="checkbox"/>	<input type="checkbox"/>	<input type="checkbox"/>	
Do the signs clearly indicate the direction of travel in all forms (visual, tactile, Braille)?	<input type="checkbox"/>	<input type="checkbox"/>	<input type="checkbox"/>	
Do brightly lit signs, displays, or objects in or near the line of vision <i>not</i> obstruct or distract attention from exit signs, particularly for people with low vision?	<input type="checkbox"/>	<input type="checkbox"/>	<input type="checkbox"/>	



## USE OF THE WAY

	YES	NO	N/A	Comments
Are circulation paths always free of obstructions, including furniture and equipment, so everyone can safely exit the building during an emergency?	<input type="checkbox"/>	<input type="checkbox"/>	<input type="checkbox"/>	
Are people <i>not</i> required to travel through a room that can be locked, such as a restroom?	<input type="checkbox"/>	<input type="checkbox"/>	<input type="checkbox"/>	
Do all interior doors, other than fire doors, readily open from the inside without keys, tools, or special knowledge and require less than 5 pounds of force to unlatch and set the door in motion?	<input type="checkbox"/>	<input type="checkbox"/>	<input type="checkbox"/>	
Are exit signs <i>not</i> obstructed or concealed in any way, particularly for people with vision impairments who need to find and feel the sign?	<input type="checkbox"/>	<input type="checkbox"/>	<input type="checkbox"/>	
Are exit doors kept free of items that obscure the visibility of exit signs or that may hide visual, tactile, or Braille signage?	<input type="checkbox"/>	<input type="checkbox"/>	<input type="checkbox"/>	
Is the emergency escape path clear of obstacles caused by construction or repair ?	<input type="checkbox"/>	<input type="checkbox"/>	<input type="checkbox"/>	
Does the circulation path maintain a clear height of 6 feet 8 inches at all points?	<input type="checkbox"/>	<input type="checkbox"/>	<input type="checkbox"/>	
Do objects that stick out into the circulation path, such as ceiling fans and wall cabinets, <i>not</i> reduce the minimum height and width of the circulation path?	<input type="checkbox"/>	<input type="checkbox"/>	<input type="checkbox"/>	
Are usable circulation paths at least 32 inches wide for any segment less than 24 inches in length and 36 inches for all segments 24 inches or longer?	<input type="checkbox"/>	<input type="checkbox"/>	<input type="checkbox"/>	
Is each usable circulation path a permanent part of the facility?	<input type="checkbox"/>	<input type="checkbox"/>	<input type="checkbox"/>	
If the circulation path is not substantially level, are occupants provided with appropriate stairs or a ramp?	<input type="checkbox"/>	<input type="checkbox"/>	<input type="checkbox"/>	
Do building circulation paths lead to a public way, that is:				
Directly outside or to a street or walkway?	<input type="checkbox"/>	<input type="checkbox"/>	<input type="checkbox"/>	
To an area of refuge and from there to a public way?	<input type="checkbox"/>	<input type="checkbox"/>	<input type="checkbox"/>	
To an open space with access to the outside?	<input type="checkbox"/>	<input type="checkbox"/>	<input type="checkbox"/>	
To streets, walkways, or open spaces large enough to accommodate all building occupants likely to use the exit?	<input type="checkbox"/>	<input type="checkbox"/>	<input type="checkbox"/>	

## TYPE OF ASSISTANCE NEEDED

	YES	NO	N/A	Comments
Can the person evacuate himself or herself with a device or aid?	<input type="checkbox"/>	<input type="checkbox"/>	<input type="checkbox"/>	
What is the specific device or aid?				



Where is the device or aid located?			
Does the person need assistance to evacuate?	<input type="checkbox"/>	<input type="checkbox"/>	<input type="checkbox"/>
What does the assistant(s) need to do?			
Does the assistant(s) need any training?	<input type="checkbox"/>	<input type="checkbox"/>	<input type="checkbox"/>
Has the training been completed?	<input type="checkbox"/>	<input type="checkbox"/>	<input type="checkbox"/>
Where will the assistant(s) meet the person requiring assistance?			
When will the person requiring assistance contact the assistant(s)?			

**Number of Assistants Needed**

How many assistants are needed?

How will the assistant(s) be contacted in an emergency?

Name	Phone	Cell Phone	E-mail
Assistant 1			
Assistant 2			
Assistant 3			
Assistant 4			
Assistant 5			
Assistant 6			

**SERVICE ANIMAL**

	YES	NO	Comments
Has the person discussed with emergency management personnel his or her preferences with regard to evacuation and handling of the service animal?	<input type="checkbox"/>	<input type="checkbox"/>	
Has the person thought about under what circumstances a decision may have to be made about leaving the service animal behind?	<input type="checkbox"/>	<input type="checkbox"/>	
What is the best way to assist the service animal if it becomes hesitant or disoriented?			
Do first responders have a copy of the detailed information for the service animal?	<input type="checkbox"/>	<input type="checkbox"/>	
Where are extra food and supplies kept for the service animal?			





## Annex A

### THE ADA: A BEGINNING

The good news is that here in the United States we have developed building codes that have significantly reduced damage and injury to people and property. We have done so well with issues like fire sprinklers, rated construction, and structural stability that we have gone on to the next level and begun to address other issues that are equally important. Energy efficiency, protection of heritage buildings, and accessibility are examples of where we have taken codes beyond traditional requirements.

The bad news is that, while we have made a good start on “accessibility” in the past 35 years, we still have a long way to go. Why does it seem to take so much time and effort to write workable codes and standards for accessibility? What makes dealing with quality-of-life issues, particularly accessibility, so difficult? After all, the goal is simple — we want everyone to have the right to the same opportunities, a right that flows directly from our Constitution. So why are we having such a hard time reaching that goal?

What makes it so difficult is simply that each one of us is unique. We certainly have many general physical features in common, like eyes and ears and organs. But there are differences even in those areas, some small, some great. My eyes are blue, yours are brown, her vision is 20/20, he is blind — there are literally billions of combinations. It’s relatively easy to write code so that we’re all protected in buildings that won’t burn or won’t collapse during an earthquake. It’s much more difficult to make sure that everyone can use a building with equal facility. We now have computer software that can “read” word documents out loud to assist people with visual impairments. We have voice-activated software that can “type” into a computer to assist people with limited use of their hands and fingers. Our goal in accessible code requirements for buildings is to provide that same kind of flexibility and to accommodate anyone and everyone who uses every building.

The first regulations for accessibility adopted in the late 1960s and early 1970s were successful and produced benefits for millions of people. Ramps, elevators, curb cuts, accessible toilets, and signage provided a new freedom for getting to, into, and around thousands of public facilities. Now we’ve learned that those adaptations are only a small part of the solution. We need to address audio and visual accessibility as well as mobility accessibility. What do people do once they’re inside a building? Where do they sit? How good is the quality of those seats? How well can people see and hear? How might they get out of the building in an emergency?

In 1990 Congress passed the Americans with Disabilities Act (ADA), which is generally considered the flagship piece of legislation on the subject of accessibility. In the act, the term *disability* means one of the following:



- ◆ A physical or mental impairment that substantially limits one or more of the major life activities of a person
- ◆ A record of such an impairment
- ◆ Being regarded as having such an impairment

In developing the ADA, Congress listed nine profound findings:

Some 43,000,000 Americans have one or more physical or mental disabilities, and this number is increasing as the population grows older.

Historically, society has tended to isolate and segregate people with disabilities. Despite some improvements, discrimination against people with disabilities continues to be a serious and pervasive social problem.

Discrimination against people with disabilities persists in the critical areas of employment, housing, public accommodations, education, transportation, communication, recreation, institutionalization, health services, voting, and access to public services. Unlike people who experience discrimination on the basis of race, color, sex, national origin, religion, or age, those of us who experience discrimination on the basis of disability often have no legal recourse to redress such discrimination.

People with disabilities continually encounter various forms of discrimination, including outright intentional exclusion; the discriminatory effects of architectural, transportation, and communication barriers; overprotective rules and policies; the effects of failure to make modifications to existing facilities and practices; exclusionary qualification standards and criteria; segregation; and relegation to lesser services, programs, activities, benefits, jobs, or other opportunities.

Census data, national polls, and other studies document that people with disabilities, as a group, occupy an inferior status in our society and are severely disadvantaged socially, vocationally, economically, and educationally. People with disabilities have been faced with restrictions and limitations, subjected to a history of purposeful unequal treatment, and relegated to a position of political powerlessness in our society, based on characteristics beyond their control and resulting from stereotypic assumptions not truly indicative of their abilities to participate in and contribute to society.

The nation's proper goals regarding people with disabilities are to ensure equality of opportunity, full participation, independent living, and economic self-sufficiency for such people. Yet, the continuing existence of unfair and unnecessary discrimination and prejudice denies people with disabilities the opportunity to compete on an equal basis and to pursue those opportunities for which our free society is justifiably famous. This discrimination costs the United



States billions of dollars in unnecessary expenses resulting from dependency and non-productivity.

Congress clearly stated its purposes in passing the ADA:

- ◆ To provide a clear and comprehensive national mandate for the elimination of discrimination against people with disabilities
- ◆ To provide clear, strong, consistent, and enforceable standards that address discrimination against people with disabilities
- ◆ To ensure that the federal government plays a central role in enforcing the standards established in the ADA on behalf of people with disabilities
- ◆ To invoke the sweep of congressional authority, including the power to enforce the 14th Amendment and to regulate commerce in order to address the major areas of discrimination that people with disabilities face daily

That clear and powerful message was sent to the American people over 15 years ago, but somehow we missed the point. Somehow we continue to miss the point. Right now, more than 43 million Americans have disabilities. The members of this group are constantly changing — at any moment, you and I could become part of this group for some period of time.

Disability is not about a specific group of people. Disability is about a specific time in the life of each and every one of us. For some it may be temporary, for others it may last much longer.

It's about the fourth-grader who breaks her leg falling off the playground slide and the hockey player who crashes into the boards 15 seconds into his first college game and is paralyzed from the neck down.

It's about the construction worker who's nearly deaf from running a jackhammer and the person born with no arms.

It's about the 30-year-old asthma sufferer and the 60-year-old office worker recuperating from bypass surgery.

It's about each and every one of us at some point in our lives.

As a society, we have mistakenly adopted a mindset that divides us into two groups, "able bodied" and "disabled." The fact is that we all will be part of the disabled community for some time in our lives. It is from that perspective that we need to think about and regulate our built environment and our programs. If we act from the perspective of what we would want when, rather than if, we become disabled, we truly will be able to make great progress for all people.



## Annex B

### GOVERNMENT RESOURCES

This listing of government resources (provided by the U.S. Access Board) may be helpful in developing integrated emergency plans that fully consider the needs of people with disabilities.

A variety of organizations in the public and private sectors provide information on accessibility and accessible design. These links are provided for information purposes only; NFPA and the U.S. Access Board make no warranty, expressed or implied, that the information obtained from these sources is accurate or correct.

[ADA Document Portal \(http://www.adaportal.org\)](http://www.adaportal.org)

This website, sponsored by the National Institute on Disability and Rehabilitation Research (NIDRR), makes available more than 3400 documents related to the ADA, including those issued by federal agencies with responsibilities under the law. It also provides extensive document collections on other disability rights laws and issues.

[Air Carrier Access Act \(http://www.airconsumer.ost.dor.gov\)](http://www.airconsumer.ost.dor.gov)

The Air Carrier Access Act prohibits discrimination by air carriers on the basis of disability. This act is enforced by the U.S. Department of Transportation, which maintains a hotline for complaints: 866-266-1368 (voice); 866-754-4368 (TTY).

[Department of Education \(http://www.ed.gov\)](http://www.ed.gov)

The U.S. Department of Education funds 10 regional [Disability Business Technical Assistance Centers \(http://www.adata.org\)](http://www.adata.org) to provide technical assistance on the ADA. For assistance related to civil rights, contact the department's [Office for Civil Rights \(OCR\)](http://bcol01.ed.gov/CFAPPS/OCR/contactus.cfm) in Washington D.C. (<http://bcol01.ed.gov/CFAPPS/OCR/contactus.cfm>) or the OCR enforcement office serving your state or territory.

[Department of Housing and Urban Development \(http://www.hud.gov/offices/fheo\)](http://www.hud.gov/offices/fheo)

The U.S. Department of Housing and Urban Development (HUD) has issued the Fair Housing Accessibility Guidelines, which cover multifamily housing and are available on HUD's website (<http://www.hud.gov/offices/fheo/disabilities/fhefhag.cfm>). Information is also available on how to file a [complaint](http://www.hud.gov/complaints/housediscrim.cfm) with HUD under the Fair Housing Act (<http://www.hud.gov/complaints/housediscrim.cfm>). HUD's website also addresses access under [Section 504](http://www.hud.gov/offices/fheo/disabilities/504keys.cfm) of the Rehabilitation Act (<http://www.hud.gov/offices/fheo/disabilities/504keys.cfm>).



[Department of Justice's ADA Website](http://www.usdoj.gov/crt/ada/adahom1.htm)  
(<http://www.usdoj.gov/crt/ada/adahom1.htm>)

The U.S. Department of Justice (DoJ) website offers technical assistance on the ADA Standards for Accessible Design and other ADA provisions that apply to businesses, nonprofit service agencies, and state and local government programs. It also provides information on how to file ADA-related complaints. Many of its [technical assistance letters](#) are available online (<http://www.usdoj.gov/crt/foia/records.htm>).

DoJ maintains an ADA hotline: 800-514-0301 (voice); 800-514-0383 (TTY).

[Department of Transportation](http://www.access-board.gov/links/government.htm#fta#fta) (<http://www.access-board.gov/links/government.htm#fta#fta>)  
(See [Federal Transit Administration](#).)

[Department of Labor, Office of Disability Employment Policy](http://www.dol.gov/odep/welcome.html)  
(<http://www.dol.gov/odep/welcome.html>)

In the fiscal year 2001 budget, Congress approved a new Office of Disability Employment Policy (ODEP) for the Department of Labor. Programs and staff of the former President's Committee on Employment of People with Disabilities have been integrated in this new office. The mission of ODEP, under the leadership of an Assistant Secretary, is to bring a heightened and permanent long-term focus on the goal of increasing employment for persons with disabilities through policy analysis, technical assistance, and development of best practices, as well as outreach, education, constituent services, and promoting ODEP's mission among employers.

[Disability and Business Technical Assistance Centers](http://www.adata.org) (<http://www.adata.org>)

Funded by the National Institute on Disability and Rehabilitation Research (NIDRR), the Disability and Business Technical Assistance Centers (DBTACs) provide information, materials, technical assistance, and training on the ADA to employers, people with disabilities, and other entities with responsibilities under the ADA. The national toll-free number, 1-800-949-4232 (voice and TTY), automatically routes calls to the closest center.

[DisabilityInfo.Gov](http://www.disabilityinfo.gov)

The website is a one-stop interagency portal for information on federal programs, services, and resources for people with disabilities, their families, employers, service providers, and other community members.

[Equal Employment Opportunity Commission](http://www.disability.gov) (<http://www.disability.gov>)

EEOC offers technical assistance on the ADA provisions that apply to employment and provides information on how to file ADA complaints.

Employment questions: 800-669-4000 (voice); 800-669-6820 (TTY)

Employment documents: 800-669-3362 (voice); 800-800-3302 (TTY)



[Federal Communications Commission](http://www.fcc.gov/cib/dro) (<http://www.fcc.gov/cib/dro>)

FCC offers technical assistance on ADA telephone relay service requirements. FCC also has jurisdiction over compliance with Section 255 of the Telecommunications Act.

Relay service—documents and questions: 202-418-0190 (voice); 202-418-2555 (TTY)

Relay service—legal questions: 202-634-1798 (voice); 202-418-0484 (TTY)

Complaints and enforcement: 202-632-7553 (voice); 202-418-0485 (TTY)

[Federal Register](http://www.gpoaccess.gov/fr/index.html) (<http://www.gpoaccess.gov/fr/index.html>)

This site not only contains the Federal Register but can access many Government Printing Office documents. It is a gateway site with access to most documents available from the Government Printing Office (*see [Government Printing Office](#)*).

[Federal Relay Service](#)

([http://www.gsa.gov/Portal/gsa/ep/contentView.do?contentType=GSA\\_OVERVIEW&contentId=10360&noc=T](http://www.gsa.gov/Portal/gsa/ep/contentView.do?contentType=GSA_OVERVIEW&contentId=10360&noc=T))

The Federal Relay Service (FRS) provides telecommunications services for persons who are deaf or hard of hearing or who have speech disabilities, to aid them in communicating and conducting business with employees in the federal government. FRS provides domestic and international coverage to the public and to federal agency personnel seven days a week, 24 hours a day.

[Federal Transit Administration](#)

([http://www.fta.dot.gov/initiatives\\_tech\\_assistance/customer\\_service/14524\\_ENG\\_HTML.htm](http://www.fta.dot.gov/initiatives_tech_assistance/customer_service/14524_ENG_HTML.htm))

The Federal Transit Administration regulates and enforces requirements of the ADA that cover transportation facilities and systems. FTA maintains a technical assistance line on ADA questions: (888) 446-4511 (voice); (202) 366-0153 (TTY).

[FirstGov.gov](http://www.firstgov.gov) (<http://www.firstgov.gov>)

This is the official U.S. gateway to all government information, and is the catalyst for a growing electronic government. The site provides a powerful search engine and links to information from the federal government, local and tribal governments, and nations around the world.

[General Service Administration Public Buildings Service](#)

(<http://www.gsa.gov/pbs/pt/pts/access.htm>)

The GSA's Public Buildings Service manages the Accessibility Program for GSA. This program provides liaison and technical staff support to the Administrator and Deputy Administrator concerning accessibility complaints against GSA facilities.



[Government Accounting Office \(http://www.gao.gov\)](http://www.gao.gov)

Reports can be downloaded or ordered directly from this site, including those on status of business, schools' compliance with the ADA, civil rights issues, and transportation issues.

[Government Printing Office \(http://www.access.gpo.gov/\)](http://www.access.gpo.gov/)

The Government Printing Office maintains its own web page with access to the Federal Register, Congressional Record, legislation, and other documents. Access through a Federal Depository Library gateway (such as the Federal Registry) is sometimes easier.

[Grants.gov \(http://www.grants.gov\)](http://www.grants.gov)

Established by a consortium of federal agencies, this website allows users to find and apply for competitive grant opportunities from all federal grant-making agencies. It contains information on more than 900 grant programs offered by 26 federal agencies.

[Internal Revenue Service \(http://www.irs.gov/index.html\)](http://www.irs.gov/index.html)

IRS provides information about tax code provisions including tax credits (section 44) and deductions (section 190) for businesses that comply with the ADA. These provisions are explained in [publication 907](#) which can be accessed online (<http://www.irs.gov/pub/irs-pdf/p907.pdf>) or ordered by calling the number below.

Tax code information: 800-829-1040 (voice); 800-829-4059 (TTY)

To order Publication 907: 800-829-3676 (voice); 800-829-4059 (TTY)

Within Washington D.C.: 202-622-3110 (voice); (for TTY, use relay service)

The Department of Justice also has information on [ADA tax incentives \(http://www.usdoj.gov/crt/ada/taxpack.htm\)](#).

[National Center for the Dissemination of Disability Research \(NCDDR\) \(http://www.ncddr.org\)](http://www.ncddr.org)

The NCDDR's purpose is to enhance the dissemination efforts of research projects funded by the National Institute on Disability and Rehabilitation Research (NIDRR) and to increase the accessibility of research outcomes for the benefit of their users, particularly those from minority backgrounds. For more information about NCDDR, see the NIDRR page at <http://www.ed.gov/about/offices/list/osers/nidrr/index.html>.

[National Council on Disability \(http://www.ncd.gov\)](http://www.ncd.gov)

The Council is a federal agency which provides recommendations to the President and Congress on overall policy issues affecting persons with disabilities. The Council developed the concept and much of the statutory language which formed the ADA.



[National Institute on Disability and Rehabilitation Research \(NIDRR\)](http://www.ed.gov/about/offices/list/osers/nidrr/index.html)  
(<http://www.ed.gov/about/offices/list/osers/nidrr/index.html>)

NIDRR is a division of the [U.S. Department of Education](http://www.ed.gov), which funds a variety of research projects and research centers around the country.

[National Institute of Standards and Technology \(NIST\)](http://www.ed.gov/about/offices/list/osers/nidrr/index.html?src=mr)  
(<http://www.ed.gov/about/offices/list/osers/nidrr/index.html?src=mr>)

NIST was established by Congress "to assist industry in the development of technology ... needed to improve product quality, to modernize manufacturing processes, to ensure product reliability ... and to facilitate rapid commercialization ... of products based on new scientific discoveries." An agency of the U.S. Department of Commerce's Technology Administration, NIST's primary mission is to promote U.S. economic growth by working with industry to develop and apply technology, measurements, and standards.

[National Science Foundation \(http://www.nsf.gov\)](http://www.nsf.gov)

The National Science Foundation is an independent U.S. government agency responsible for promoting science and engineering through programs involving almost 20,000 research and education projects in science and engineering. Some projects focus on technology and people with disabilities.

[Office of Disability Employment Policy \(Department of Labor\)](http://www.dol.gov/odep/welcome.html)  
(<http://www.dol.gov/odep/welcome.html>)

The Office of Disability Employment Policy at the Department of Labor (previously the President's Committee on Employment of People with Disabilities) answers employment questions and funds the [Job Accommodation Network \(JAN\)](http://www.jan.wvu.edu) (<http://www.jan.wvu.edu>), which provides advice on accommodating employees with disabilities.

Employment questions: 202-376-6200 (voice); 202-376-6205 (TTY)

Job Accommodation Network: 800-526-7234 (voice and TTY)

[Project Safe EV-AC \(http://evac.icdi.wvu.edu/what.htm\)](http://evac.icdi.wvu.edu/what.htm)

Project Safe EV-AC, a three year development project, will improve evacuation from buildings, vehicles, and other settings during emergencies by providing training materials on the **EV**acuation and **AC**commodation of people with disabilities. Project Safe EV-AC is targeting specific audiences, including people with disabilities and emergency responders. (See "A Practical Handbook for Emergency Planning" at <http://evac.icdi.wvu.edu/library/InAdvance.pdf>.)

[Regulatory Information Service Center \(http://reginfo.gov\)](http://reginfo.gov)

The Regulatory Information Service Center has established the [reginfo.gov](http://reginfo.gov) site to assist users who want to find information about federal, state, and local regulations. The Center is a federal government office located in the General Services Administration, with responsibility for gathering and publishing information on federal regulations.





[Smithsonian Institution Accessibility Program](http://www.si.edu/visit/visitors_with_disabilities.htm)  
([http://www.si.edu/visit/visitors\\_with\\_disabilities.htm](http://www.si.edu/visit/visitors_with_disabilities.htm))

This site provides information on accessibility to the Smithsonian Institution and access maps of museums on and near the National Mall, with specific guidance to those designing exhibits in the [Smithsonian Guidelines for Accessible Exhibition Design](http://www.si.edu/opa/accessibility/exdesign/start.htm) (<http://www.si.edu/opa/accessibility/exdesign/start.htm>).

Tax Incentives (See [Internal Revenue Service](#).)

[Thomas](http://thomas.loc.gov) (<http://thomas.loc.gov>)

This is the site operated by the Library of Congress where one can obtain status and full text of current and previous year's legislation, as well as the Congressional Record.

[Transportation Security Administration \(TSA\)](http://www.tsa.dot.gov) (<http://www.tsa.dot.gov>)

TSA, the new entity within the Department of Transportation responsible for protecting the nation's transit system, has issued [guidance](http://www.tsa.gov/public/display?theme=156) to air travelers (<http://www.tsa.gov/public/display?theme=156>), including those with disabilities, on new security screening procedures.

[Usability.gov](http://www.usability.gov) (<http://www.usability.gov>)

This site is designed to provide current and accurate information on how to make websites and other user interfaces more accessible and useful for people with disabilities. Information is provided by the National Cancer Institute (NCI), the federal government's principal agency for cancer research. The site also links to a variety of quality websites and resources on usability, accessibility, and related topics.

[U.S. House of Representatives](http://www.house.gov) (<http://www.house.gov>)

This site provides links to House bills passed and pending, hearing schedules, and other resources.

[U.S. Senate](http://www.senate.gov) (<http://www.senate.gov>)

This site provides links to Senate bills passed and pending, hearing schedules, and other resources.

[Vocational Rehabilitation State Offices](http://www.jan.wvu.edu/sbses/vocrehab.htm)  
(<http://www.jan.wvu.edu/sbses/vocrehab.htm>)

Vocational Rehabilitation (VR), a state-supported division of services, assists people with disabilities who are pursuing employment. VR helps those people to secure gainful employment commensurate with their abilities and capabilities through local job searches and awareness of self-employment and telecommuting opportunities.

[The White House](http://www.whitehouse.gov) (<http://www.whitehouse.gov>)

This site provides access to Presidential speeches and press releases, and links to Executive Branch agencies.



## Annex C

### EXCERPTS FROM U.S. ACCESS BOARD'S ADA-ABA-AG (JULY 2004)

The excerpts in this annex are a listing of key provisions of the U.S. Access Board's ADA-ABA-AG. Released in 2004, these updated accessibility guidelines detail how accessibility is to be achieved in new construction and alterations, and they provide specifications for various building elements and spaces.

#### 702 Fire Alarm Systems

**702.1 General.** Fire alarm systems shall have permanently installed audible and visible alarms complying with [NFPA 72](#) (1999 or 2002 edition) (incorporated by reference, see "Referenced Standards" in Chapter 1), except that the maximum allowable sound level of audible notification appliances complying with section 4-3.2.1 of [NFPA 72](#) (1999 edition) shall have a sound level no more than 110 dB at the minimum hearing distance from the audible appliance. In addition, alarms in guest rooms required to provide communication features shall comply with sections 4-3 and 4-4 of [NFPA 72](#) (1999 edition) or sections 7.4 and 7.5 of [NFPA 72](#) (2002 edition).

**EXCEPTION:** Fire alarm systems in medical care facilities shall be permitted to be provided in accordance with industry practice.

#### 703 Signs

**703.1 General.** Signs shall comply with 703. Where both visual and tactile characters are required, either one sign with both visual and tactile characters, or two separate signs, one with visual, and one with tactile characters, shall be provided.

**703.2 Raised Characters.** Raised characters shall comply with 703.2 and shall be duplicated in Braille complying with 703.3. Raised characters shall be installed in accordance with 703.4.

**Advisory 703.2 Raised Characters.** Signs that are designed to be read by touch should not have sharp or abrasive edges.

**703.2.1 Depth.** Raised characters shall be 1/32 inch (0.8 mm) minimum above their background.

**703.2.2 Case.** Characters shall be uppercase.

**703.2.3 Style.** Characters shall be sans serif. Characters shall not be italic, oblique, script, highly decorative, or of other unusual forms.



**703.2.4 Character Proportions.** Characters shall be selected from fonts where the width of the uppercase letter "O" is 55 percent minimum and 110 percent maximum of the height of the uppercase letter "I".

**703.2.5 Character Height.** Character height measured vertically from the baseline of the character shall be  $\frac{5}{8}$  inch (16 mm) minimum and 2 inches (51 mm) maximum based on the height of the uppercase letter "I".

**EXCEPTION:** Where separate raised and visual characters with the same information are provided, raised character height shall be permitted to be inch (25 mm) minimum.

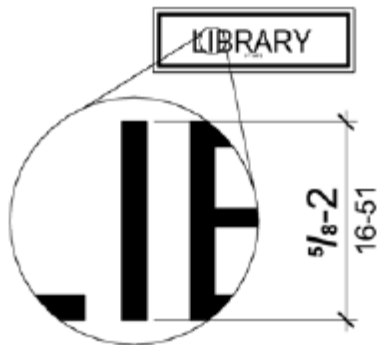

**Figure 703.2.5**  
**Height of Raised Characters**

**703.2.6 Stroke Thickness.** Stroke thickness of the uppercase letter "I" shall be 15 percent maximum of the height of the character.

**703.2.7 Character Spacing.** Character spacing shall be measured between the two closest points of adjacent raised characters within a message, excluding word spaces. Where characters have rectangular cross sections, spacing between individual raised characters shall be  $\frac{1}{8}$  inch (3.2 mm) minimum and 4 times the raised character stroke width maximum. Where characters have other cross sections, spacing between individual raised characters shall be  $\frac{1}{16}$  inch (1.6 mm) minimum and 4 times the raised character stroke width maximum at the base of the cross sections, and  $\frac{1}{8}$  inch (3.2 mm) minimum and 4 times the raised character stroke width maximum at the top of the cross sections. Characters shall be separated from raised borders and decorative elements  $\frac{3}{8}$  inch (9.5 mm) minimum.

**703.2.8 Line Spacing.** Spacing between the baselines of separate lines of raised characters within a message shall be 135 percent minimum and 170 percent maximum of the raised character height.

**703.3 Braille.** Braille shall be contracted (Grade 2) and shall comply with 703.3 and 703.4.

**703.3.1 Dimensions and Capitalization.** Braille dots shall have a domed or rounded shape and shall comply with Table 703.3.1. The indication of an uppercase letter or letters shall only be used before the first word of sentences, proper nouns and names, individual letters of the alphabet, initials, and acronyms.

**703.3.1 Braille Dimensions**

Measurement Range	Minimum in Inches Maximum in Inches
Dot base diameter	0.059 (1.5 mm) to 0.063 (1.6 mm)
Distance between two dots in the same cell <sup>1</sup>	0.090 (2.3 mm) to 0.100 (2.5 mm)
Distance between corresponding dots in adjacent cells <sup>1</sup>	0.241 (6.1 mm) to 0.300 (7.6 mm)
Dot height	0.025 (0.6 mm) to 0.037 (0.9 mm)
Distance between corresponding dots from one cell directly below <sup>1</sup>	0.395 (10 mm) to 0.400 (10.2 mm)

1. Measured center to center.

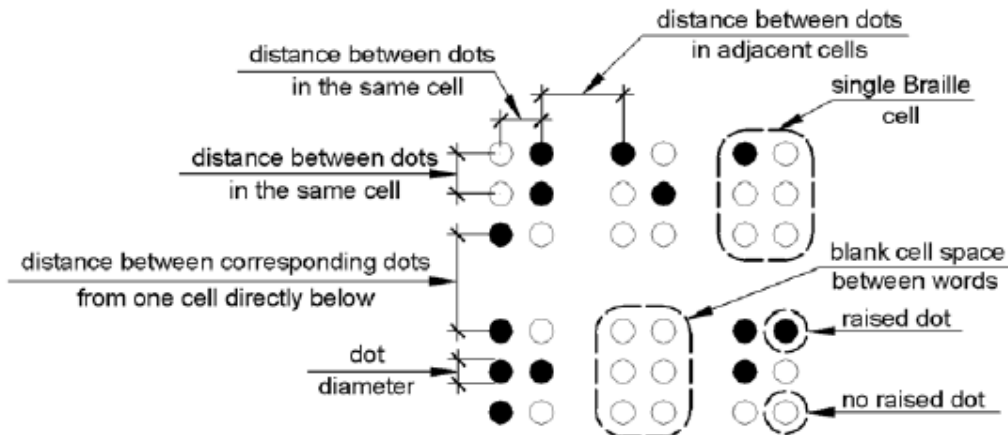

**Figure 703.3.1**  
**Braille Measurement**

**703.3.2 Position.** Braille shall be positioned below the corresponding text. If text is multi-lined, Braille shall be placed below the entire text. Braille shall be separated 3/8 inch (9.5 mm) minimum from any other tactile characters and 3/8 inch (9.5 mm) minimum from raised borders and decorative elements.

**EXCEPTION:** Braille provided on elevator car controls shall be separated 3/16 inch (4.8 mm) minimum and shall be located either directly below or adjacent to the corresponding raised characters or symbols.

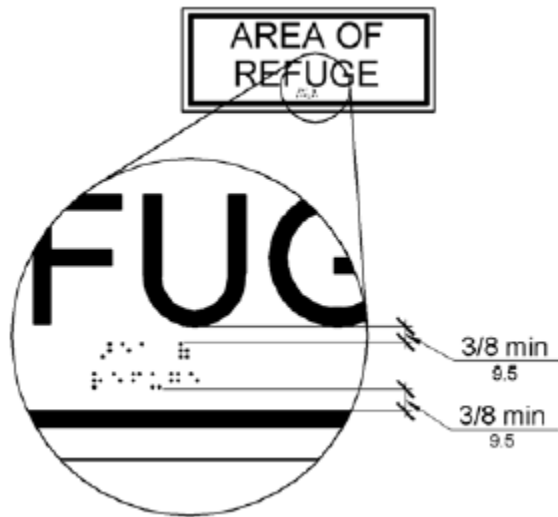
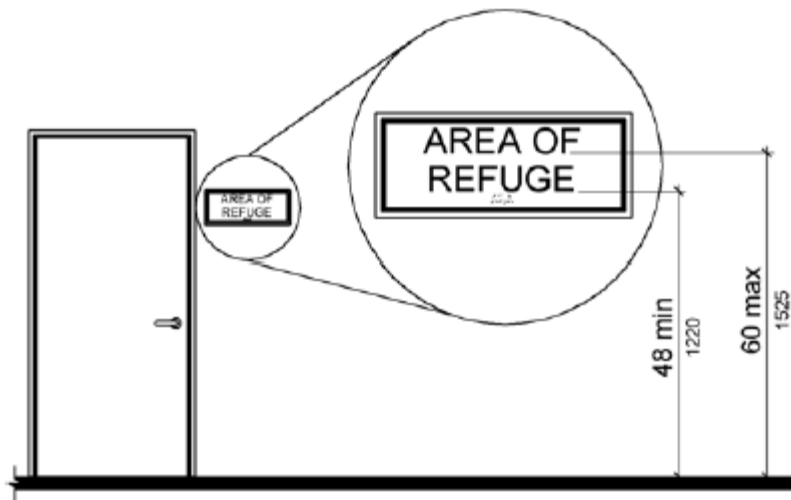

**Figure 703.3.2**  
**Position of Braille**

**703.4 Installation Height and Location.** Signs with tactile characters shall comply with 703.4.

**703.4.1 Height Above Finish Floor or Ground.** Tactile characters on signs shall be located 48 inches (1220 mm) minimum above the finish floor or ground surface, measured from the baseline of the lowest tactile character and 60 inches (1525 mm) maximum above the finish floor or ground surface, measured from the baseline of the highest tactile character.

**EXCEPTION:** Tactile characters for elevator car controls shall not be required to comply with 703.4.1.



**Figure 703.4.1**  
**Height of Tactile Characters Above Finish Floor or Ground**

**703.4.2 Location.** Where a tactile sign is provided at a door, the sign shall be located alongside the door at the latch side. Where a tactile sign is provided at double doors with one active leaf, the sign shall be located on the inactive leaf. Where a tactile sign is provided at double doors with two active leaves, the sign shall be located to the right of the right hand door. Where there is no wall space at the latch side of a single door or at the right side of double doors, signs shall be located on the nearest adjacent wall. Signs containing tactile characters shall be located so that a clear floor space of 18 inches (455 mm) minimum by 18 inches (455 mm) minimum, centered on the tactile characters, is provided beyond the arc of any door swing between the closed position and 45 degree open position.

**EXCEPTION:** Signs with tactile characters shall be permitted on the push side of doors with closers and without hold-open devices.

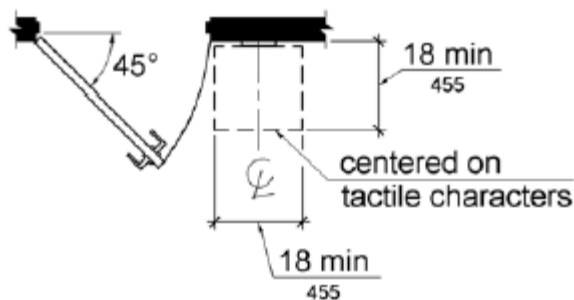

**Figure 703.4.2**  
**Location of Tactile Signs at Doors**

**703.5 Visual Characters.** Visual characters shall comply with 703.5.

**EXCEPTION:** Where visual characters comply with 703.2 and are accompanied by braille complying with 703.3, they shall not be required to comply with 703.5.2 through 703.5.9.

**703.5.1 Finish and Contrast.** Characters and their background shall have a non-glare finish. Characters shall contrast with their background with either light characters on a dark background or dark characters on a light background.

**Advisory 703.5.1 Finish and Contrast.** Signs are more legible for persons with low vision when characters contrast as much as possible with their background. Additional factors affecting the ease with which the text can be distinguished from its background include shadows cast by lighting sources, surface glare, and the uniformity of the text and its background colors and textures.

**703.5.2 Case.** Characters shall be uppercase or lowercase or a combination of both.

**703.5.3 Style.** Characters shall be conventional in form. Characters shall not be italic, oblique, script, highly decorative, or of other unusual forms.

**703.5.4 Character Proportions.** Characters shall be selected from fonts where the width of the uppercase letter "O" is 55 percent minimum and 110 percent maximum of the height of the uppercase letter "I".

**703.5.5 Character Height.** Minimum character height shall comply with Table 703.5.5. Viewing distance shall be measured as the horizontal distance between the character and an obstruction preventing further approach towards the sign. Character height shall be based on the uppercase letter "I".

**703.5.5 Visual Character Height**

Height to Finish Floor or Ground From Baseline of Character	Horizontal Viewing Distance	Minimum Character Height
40 inches (1015 mm) to less than or equal to 70 inches (1780 mm)	less than 72 inches (1830 mm)	5/8 inch (16 mm)
	72 inches (1830 mm) and greater	5/8 inch (16 mm), plus 1/8 inch (3.2 mm) per foot (305 mm) of viewing distance above 72 inches (1830 mm)
Greater than 70 inches (1780 mm) to less than or equal to 120 inches (3050 mm)	less than 180 inches (4570 mm)	2 inches (51 mm)
	180 inches (4570 mm) and greater	2 inches (51 mm), plus 1/8 inch (3.2 mm) per foot (305 mm) of viewing distance above 180 inches (4570 mm)
greater than 120 inches (3050 mm)	less than 21 feet (6400 mm)	3 inches (75 mm)
	21 feet (6400 mm) and greater	3 inches (75 mm), plus 1/8 inch (3.2 mm) per foot (305 mm) of viewing distance above 21 feet (6400 mm)

**703.5.6 Height From Finish Floor or Ground.** Visual characters shall be 40 inches (1015 mm) minimum above the finish floor or ground.



**EXCEPTION:** Visual characters indicating elevator car controls shall not be required to comply with 703.5.6.

**703.5.7 Stroke Thickness.** Stroke thickness of the uppercase letter "I" shall be 10 percent minimum and 30 percent maximum of the height of the character.

**703.5.8 Character Spacing.** Character spacing shall be measured between the two closest points of adjacent characters, excluding word spaces. Spacing between individual characters shall be 10 percent minimum and 35 percent maximum of character height.

**703.5.9 Line Spacing.** Spacing between the baselines of separate lines of characters within a message shall be 135 percent minimum and 170 percent maximum of the character height.

**703.6 Pictograms.** Pictograms shall comply with 703.6.

**703.6.1 Pictogram Field.** Pictograms shall have a field height of 6 inches (150 mm) minimum. Characters and Braille shall not be located in the pictogram field.

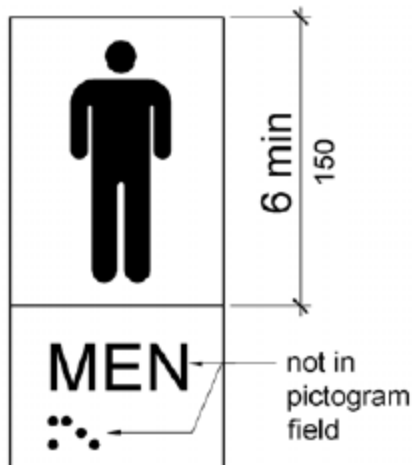

**Figure 703.6.1**  
**Pictogram Field**

**703.6.2 Finish and Contrast.** Pictograms and their field shall have a non-glare finish. Pictograms shall contrast with their field with either a light pictogram on a dark field or a dark pictogram on a light field.

**Advisory 703.6.2 Finish and Contrast.** Signs are more legible for persons with low vision when characters contrast as much as possible with their background. Additional factors affecting the ease with which the text can be distinguished from its background include shadows cast by lighting sources, surface glare, and the uniformity of the text and background colors and textures.



**703.6.3 Text Descriptors.** Pictograms shall have text descriptors located directly below the pictogram field. Text descriptors shall comply with 703.2, 703.3 and 703.4.

**703.7 Symbols of Accessibility.** Symbols of accessibility shall comply with 703.7.

**703.7.1 Finish and Contrast.** Symbols of accessibility and their background shall have a non-glare finish. Symbols of accessibility shall contrast with their background with either a light symbol on a dark background or a dark symbol on a light background.

**Advisory 703.7.1 Finish and Contrast.** Signs are more legible for persons with low vision when characters contrast as much as possible with their background. Additional factors affecting the ease with which the text can be distinguished from its background include shadows cast by lighting sources, surface glare, and the uniformity of the text and background colors and textures.

**703.7.2 Symbols.**

**703.7.2.1 International Symbol of Accessibility.** The International Symbol of Accessibility shall comply with Figure 703.7.2.1.



**Figure 703.7.2.1**  
**International Symbol of Accessibility**

**703.7.2.2 International Symbol of TTY.** The International Symbol of TTY shall comply with Figure 703.7.2.2.



**Figure 703.7.2.2**  
**International Symbol of TTY**

**703.7.2.3 Volume Control Telephones.** Telephones with a volume control shall be identified by a pictogram of a telephone handset with radiating sound waves on a square field such as shown in Figure 703.7.2.3.



**Figure 703.7.2.3**  
**Volume Control Telephone**

**703.7.2.4 Assistive Listening Systems.** Assistive listening systems shall be identified by the International Symbol of Access for Hearing Loss complying with Figure 703.7.2.4.



**Figure 703.7.2.4**  
**International Symbol of Access for Hearing Loss**

## Annex D

### SELECTED EXAMPLES OF THE SCOPE OF THE ADA

#### *Employment-Related Discrimination*

**§102(a) General Rule.** No covered entity shall discriminate against a qualified individual with a disability because of the disability of such individual in regard to job application procedures, the hiring, advancement, or discharge of employees, employee compensation, job training, and other terms, conditions, and privileges of employment.

#### *Discrimination in Public Accommodations*

**§302(a) General Rule.** No individual shall be discriminated against on the basis of disability in the full and equal enjoyment of the goods, services, facilities, privileges, advantages, or accommodations of any place of public accommodation by any person who owns, leases (or leases to), or operates a place of public accommodation.

**§301(7) Public accommodation.** The following private entities are considered public accommodations for purposes of this title, if the operations of such entities affect commerce

**§301(7)(A)** an inn, hotel, motel, or other place of lodging, except for an establishment located within a building that contains not more than five rooms for rent or hire and that is actually occupied by the proprietor of such establishment as the residence of such proprietor;

**§301(7)(B)** a restaurant, bar, or other establishment serving food or drink;

**§301(7)(C)** a motion picture house, theater, concert hall, stadium, or other place of exhibition or entertainment;

**§301(7)(D)** an auditorium, convention center, lecture hall, or other place of public gathering;

**§301(7)(E)** a bakery, grocery store, clothing store, hardware store, shopping center, or other sales or rental establishment;

**§301(7)(F)** a laundromat, dry-cleaner, bank, barber shop, beauty shop, travel service, shoe repair service, funeral parlor, gas station, office of an accountant or lawyer, pharmacy, insurance office, professional office of a health care provider, hospital, or other service establishment;

**§301(7)(G)** a terminal, depot, or other station used for specified public transportation;



**§301(7)(H)** a museum, library, gallery, or other place of public display or collection;

**§301(7)(I)** a park, zoo, amusement park, or other place of recreation;

**§301(7)(J)** a nursery, elementary, secondary, undergraduate, or postgraduate private school, or other place of education;

**§301(7)(K)** a day care center, senior citizen center, homeless shelter, food bank, adoption agency, or other social service center establishment; and

**§301(7)(L)** a gymnasium, health spa, bowling alley, golf course, or other place of exercise or recreation.

**§301(8)** Rail and railroad. The terms "rail" and "railroad" have the meaning given the term "railroad" in section 202(e) of the Federal Railroad Safety Act of 1970 (45 U.S.C. 431(e)).

***Discrimination in Specific Public Transportation Services Provided by Private Entities***

**§304(a) General Rule.** No individual shall be discriminated against on the basis of disability in the full and equal enjoyment of specified public transportation services provided by a private entity that is primarily engaged in the business of transporting people and whose operations affect commerce.